

Tous droits strictement réservés. Reproduction ou communication à des tiers interdite sous quelque forme que ce soit sans autorisation écrite du propriétaire. Propriété de c FCI. Droits de reproduction FCI.

All rights strictly reserved. Reproduction or issue to third parties in any form whatever is not permitted without written authority from the proprietor. Property of FCI. Copyright FCI.

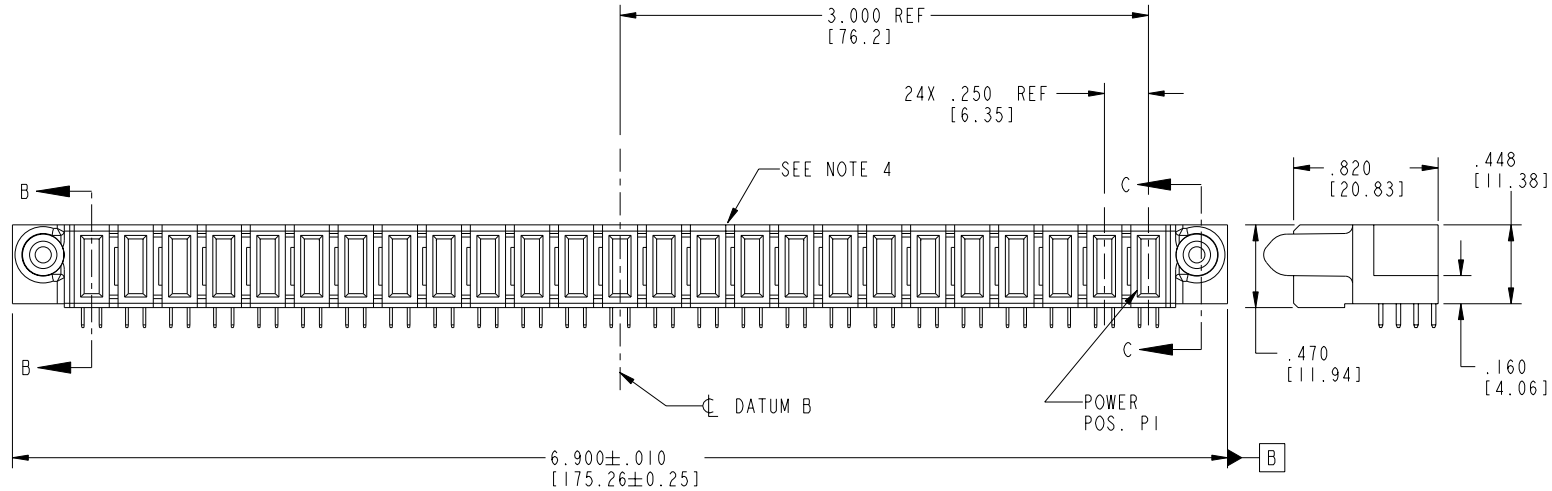
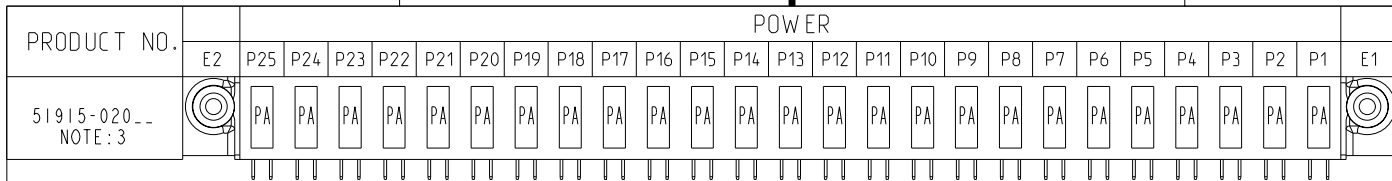

CODE	DIM "M" MATING LENGTH	CONTACT TYPE
PA	.042 [1.07]	POWER

mat'l code		SEE NOTE 2		tolerances unless otherwise specified		CUSTOMER		 www.fciconnect.com	
ltr	ecn no.	dr	date	linear	projection	COPY		title	
A	V03-0011	TAB	01/08/03	.XX±.01/0.X±0.3				25P	
B	DG05-0355	CS	09/27/05	.XXX±.005/0.XX±0.13				R/A SOLDER RECEPTACLE	
				angles		INCH/MM		product family	
				dr	1:1			PwrBlade	
				engr				code	
				chr				213	
				appd				sheet	
								1 of 4	
sheet index	revision	B	B	B	B				
	sheet	1	2	3	4				

cage code 22526 4

PDM: Rev:B

STATUS: Released

Printed: Aug 15, 2007

Tous droits strictement réservés. Reproduction ou communication a des tiers interdite sous quelque forme que ce soit sans autorisation écrite du propriétaire. Propriété de c FCI. Droits de reproduction FCI.

All rights strictly reserved. Reproduction or issue to third parties in any form whatever is not permitted without written authority from the proprietor. Property of FCI. Copyright FCI.

PRODUCT NUMBER  
51915-020\_\_  
NOTE: 3

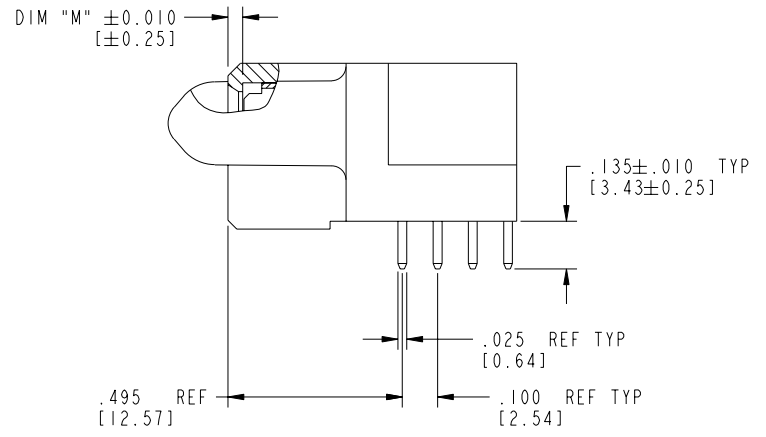

BROKEN-OUT SECTION B-B  
SCALE 2:1

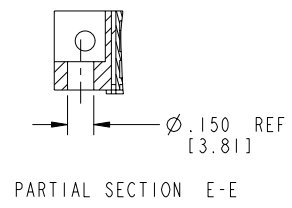
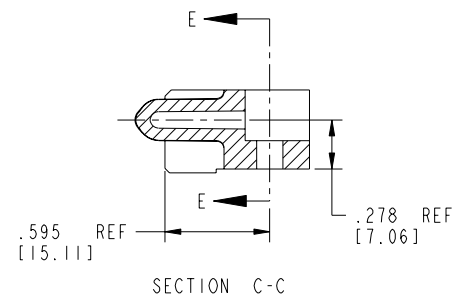

mat'l code		SEE NOTE 2		tolerances unless otherwise specified		CUSTOMER		 www.fciconnect.com	
ltr	ecn no.	dr	date	linear	.XX±.01/0.X±0.3	COPY		projection	title
B					.XXX±.005/0.XX±0.13				25P
				angles	.XXXX±.0020/0.XXX±0.051				R/A SOLDER RECEPTACLE
				dr	T. BRUNGARD 01/08/03	INCH/MM		product family	PwrBlade
				enr	M. MOSTOLLER 01/08/03	1:1		size	213
				chr	M. MOSTOLLER 01/08/03			scale	2 of 4
				appd	M. MOSTOLLER 01/08/03			dwg no	51915-020
sheet index	revision sheet								

cage code 22526

Pro/E

PDM: Rev:B

STATUS: Released

Printed: Aug 15, 2007

Tous droits strictement réservés. Reproduction ou communication à des tiers interdite sous quelque forme que ce soit sans autorisation écrite du propriétaire. Propriété de c FCI. Droits de reproduction FCI.

All rights strictly reserved. Reproduction or issue to third parties in any form whatever is not permitted without written authority from the proprietor. Property of FCI. Copyright FCI.

**FCI**

PRODUCT NUMBER  
51915-020\_\_  
NOTE: 3

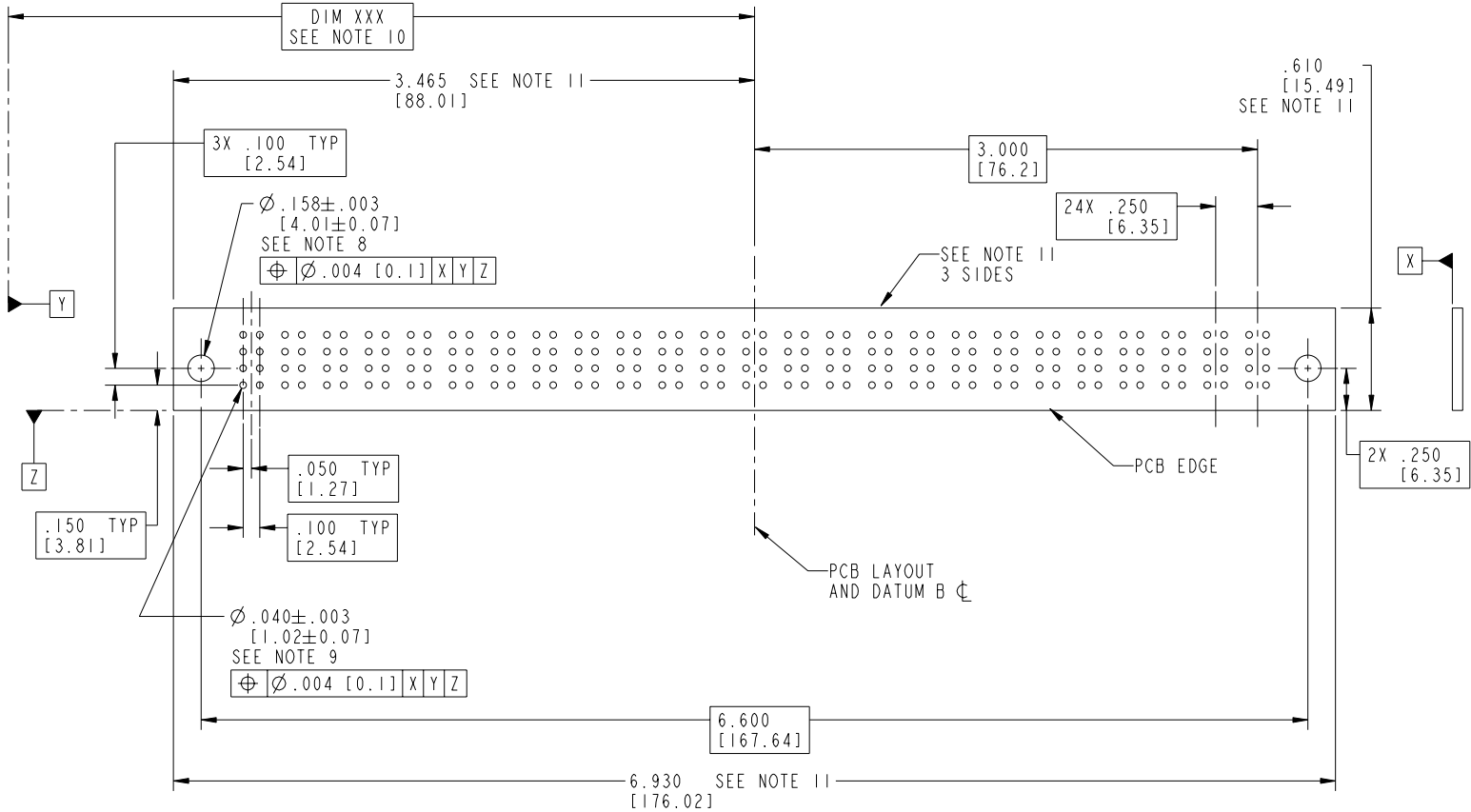

mat'l code		SEE NOTE 2		tolerances unless otherwise specified		CUSTOMER		<b>FCI</b>		www.fciconnect.com	
ltr	ecn no.	dr	date	linear	.XX±.01/0.XX±0.3	COPY		projection		title	
B					.XXX±.005/0.XX±0.13			A		25P	
				angles	.XXX±.0020/0.XX±0.051			INCH/MM		R/A SOLDER RECEPTACLE	
				dr	0°±2°			product family		PwrBlade	
				enrg	T. BRUNGARD 01/08/03	scale		size		code	
				chr	M. MOSTOLLER 01/08/03	1:1		A		213	
				appd	M. MOSTOLLER 01/08/03			51915-020		sheet	
sheet index	revision sheet									3 of 4	

cage code 22526 4

Pro/E

PDM: Rev:B

STATUS: Released

Printed: Aug 15, 2007

Tous droits strictement réservés. Reproduction ou communication à des tiers interdite sous quelque forme que ce soit sans autorisation écrite du propriétaire. Propriété de c FCI. Droits de reproduction FCI.

All rights strictly reserved. Reproduction or issue to third parties in any form whatever is not permitted without written authority from the proprietor. Property of FCI. Copyright FCI.

1 | 2

3 |

4

PRODUCT NUMBER  
51915-020\_\_  
NOTE: 3

NOTES:

1. DIMENSIONS AND TOLERANCES ARE IN ACCORDANCE WITH ASME Y14.5M, 1994 UNLESS OTHERWISE SPECIFIED.

CONNECTOR NOTES:

2. HOUSING MATERIAL: UL 94 V-0 GLASS FILLED HIGH-TEMP THERMOPLASTIC  
POWER CONTACT MATERIAL: COPPER ALLOY  
SIGNAL PIN MATERIAL: COPPER ALLOY

3. PLATING:  
51915-020 Singal Pin: 30u"/0.76um Au OVER 50u"/1.27um Ni ON THE CONTACT AREA, AND 100u"/2.54um SnPb PLATING OVER 50u"/1.27um Ni ON THE TERMINATION SECTION.  
Power Pin: 30u"/0.76um Au OVER 50u"/1.27um Ni ON THE CONTACT AREA, AND 100u"/2.54um SnPb PLATING OVER 50u"/1.27um Ni ON THE TERMINATION SECTION.  
51915-020LF Singal Pin: 30u"/0.76um Au OVER 50u"/1.27um Ni ON THE CONTACT AREA, AND 78u"/2.00um Sn PLATING OVER 50u"/1.27um Ni ON THE TERMINATION SECTION.  
Power Pin: 30u"/0.76um Au OVER 50u"/1.27um Ni ON THE CONTACT AREA, AND 78u"/2.00um Sn PLATING OVER 50u"/1.27um Ni ON THE TERMINATION SECTION.

PART NUMBER 51915-020LF MEETS EUROPEAN UNION DIRECTIVE AND OTHER COUNTRY REGULATIONS AS DESCRIBED IN GS-22-008.

THE HOUSING WILL WITHSTAND EXPOSURE TO 260° PEAK TEMPERATURE FOR 10 SECONDS IN A WAVE SOLDER APPLICATION WITH A CIRCUIT BOARD.



4. MANUFACTURER'S NAME, P/N, AND DATE CODE TO APPEAR ON THIS SURFACE.  
5. PRODUCT SPECIFICATION GS-12-149. APPLICATION SPECIFICATION BUS-20-067.  
6. PACKAGED IN TRAYS.

PCB NOTES:

7. ALL HOLE DIAMETERS ARE FINISHED HOLE SIZE.  
8. MOUNTING HOLES, WHERE APPLICABLE, ARE UNPLATED.  
9.  $\varnothing .0453 \pm .0010$  [1.151 ± 0.025] DRILLED HOLES PLATED WITH .0003 [0.008] MIN SnPb OVER .001 [0.03] TO .003 [0.08] Cu PLATING TO ACHIEVE  $\varnothing .040 \pm .003$  [1.02 ± .07] HOLE.

10. "DIM XXX" TO BE DETERMINED BY THE CUSTOMER.

11. CONNECTOR KEEP-OUT ZONE.

mat'l code				SEE NOTE 2		tolerances unless otherwise specified		CUSTOMER		 www.fciconnect.com	
ltr	ecn no.	dr	date	linear	.XX±.01/0.X±0.3	COPY		projection		title	
B					.XXX±.005/0.XX±0.13					25P	
				angles	.XXX±.002/0.XX±0.051					R/A SOLDER RECEPTACLE	
				dr	0 ± 2°	T. BRUNGARD 01/08/03		INCH/MM		product family	
				enrg		M. MOSTOLLER 01/08/03		1:1		PwrBlade	
				chr		M. MOSTOLLER 01/08/03		A		code	
				appd		M. MOSTOLLER 01/08/03		A		213	
sheet index		revision sheet								size	
										51915-020	
										4 of 4	

cage code 22526

4

1 | 2

Pro/E

3 |

PDM: Rev:B

STATUS: Released

Printed: Aug 15, 2007